



## FRM CW Fiber Laser

### YLP-FRM-1500/1500-W-M/M

Adjustable beam fiber laser adopts FRM ring dynamic spot output technology, high brightness center beam and ring beam can be independently controlled, flexible control of the output beam, the center beam and ring beam can achieve closed-loop control of laser energy output, making the laser welding process more stable and reliable.

#### Advantages

- Full-fiber architecture output, high-brightness center beam and ring beam output power can be independently controlled, one machine is equivalent to three;
- Laser power closed-loop control, laser welding process is more stable and reliable, welding depth consistency is high, the penetration depth fluctuation is  $\pm 0.15\text{mm}$ ;
- ABR anti-high reflection design, suitable for welding high reflection materials;
- Outer ring preheating, stable welding process, beautiful forming, fast welding speed, almost zero splash.

#### Applications

Suitable for welding aluminum alloy, copper and other high reverse materials, currently widely used in new energy battery welding, welding parts including: transfer plate, busbar, explosion-proof valve, sealing nail and pole.

The professional performance laser series of GW is aimed at customers who have the pursuit of product performance indicators, the replacement of imported products or the product functionality requirements. Product design to the first-line brand, with better product performance indicators, perfect functions, design redundancy is greater, to provide customers with more value-added space.

- Optimized for laser platform welding applications and remote laser welding applications of galvanometer scanning systems
- The laser energy output can be closed loop control of the center beam and the ring beam
- ABR anti-reflection design, suitable for a variety of high reflective materials processing applications
- FRM ring dynamic spot output technology



EO conversion efficiency  $\geq 42\%$



Easily process high anti materials



The inner and outer ring power is adjusted



Almost zero splash, beautiful shape

# FRM CW Fiber Laser

## YLP-FRM-1500/1500-W-M/M

Product specification parameter	YLP-FRM-1500/1500-W-M/M
Output Power (watt)	1500/1500
Operating Mode	CW/Pulse/self-set pulse mode
Output Power Range (%)	1-100
Output Laser Wavelength (nm)	1070±10
Beam Quality	Center $M^2 \leq 5$ , Ring $M^2 \leq 15$
Interface Type	QBH
Delivery Fiber Core Diameter (conventional configuration, optional)	50um/150um
Cooling Method	Water-cooling
Ambient Temperature Range (°C)	5-45
Input Voltage	380VAC/50Hz
Dimension (mm)	700 x 300 x 667 (L×W×H)
Weight (kg)	< 120

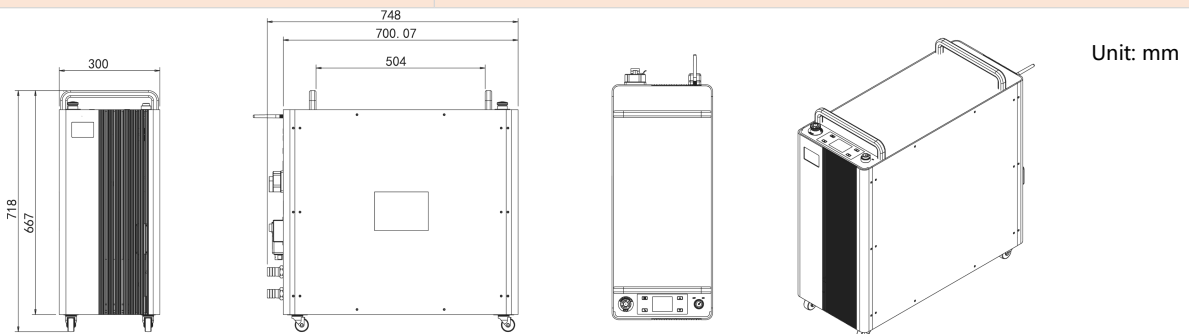

Legal Notice: All product information is believed to be accurate and subject to change without notice.

### Legal statement:

GW smart fiber laser products are designed in strict accordance with safety regulations. All production is in accordance with international standards and regulations currently in force in the country. Each GW laser has a warning sign as shown in the figure.

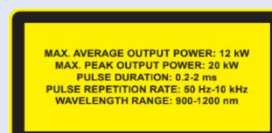

GW(Shanghai) Laser Technology Co.,Ltd. Tel: +86 2139721122 Email: sales@gwlaser.tech  
Web: [www.gwlaser.tech](http://www.gwlaser.tech) Addr: Building 5-1, No.398, Shuanglian Road, Xujing Town, Qingpu District, Shanghai